

NAPCO

M113 CAPABILITIES

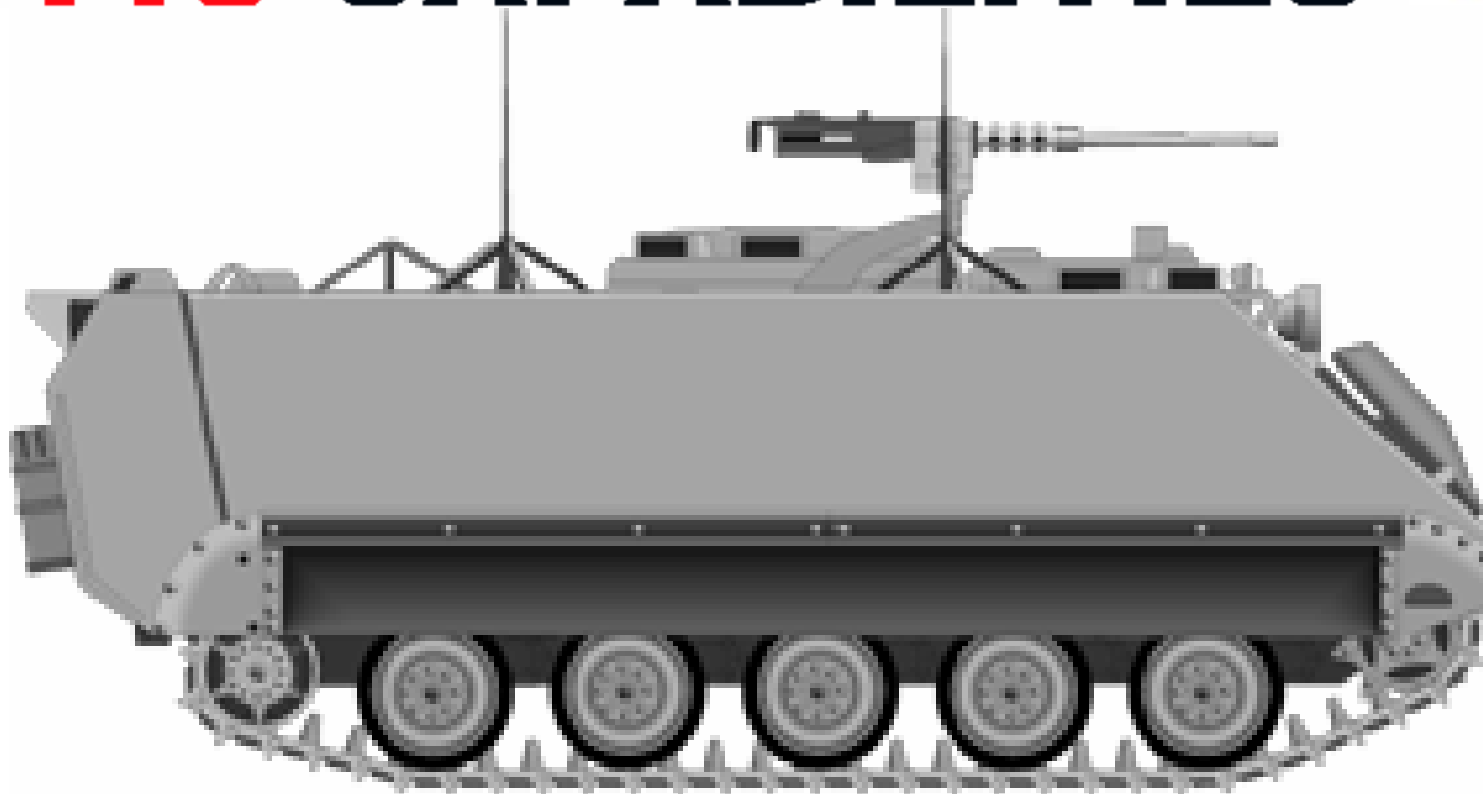

www.napcointl.com

NAPCO International LLC

11055 Excelsior Blvd.
Hopkins, MN 55343 USA
telephone: (952) 931-2400
facsimile: (952) 931-2402
e-mail: napco@napcointl.com

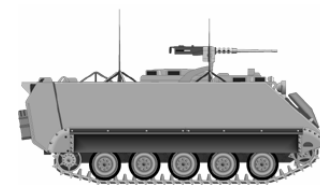

NAPCO's background

In continuous business for over 80 years, NAPCO's has earned worldwide respect as a leading supplier of high quality spare parts, assemblies and complete logistics services for a wide range of combat and tactical vehicles to the U.S. Department of Defense, NATO and over 60 Defense Forces around the world. Strong company resources enable complete logistics and manufacturing support, design and installation of vehicle upgrades, field repair and production of advanced products for all combat areas.

- **Manufacturing Expertise.** Using detailed historical records and our extensive library of technical manuals and ordnance drawings, we manufacture new parts at our machining facility for most modern vehicles as well as those long since out of production. Major manufactured assemblies include - transfer cases, final drives and steering differentials for tracked and wheeled vehicles. NAPCO has been an OEM of Detroit Diesel Corporation since 1972.
- **Inventory Management.** To meet your urgent requirements, we maintain an extensive 50,000 line item inventory of fast moving items, as well as hard to find parts, at our 12,000 square meter warehouse in Minneapolis, Minnesota USA.
- **Unique Procurement Support.** Continuously updated purchase records allow us to quickly locate experienced vendors capable of building virtually any part to your requirements. Through extensive contacts, we are able to select qualified vendors on the basis of quality, craftsmanship and carefully managed costs - all of which work to your advantage.

www.napcointl.com

NAPCO International LLC

11055 Excelsior Blvd.

Hopkins, MN 55343 USA

telephone: (952) 931-2400

facsimile: (952) 931-2402

e-mail: napco@napcointl.com

NAPCO

M113 CAPABILITIES

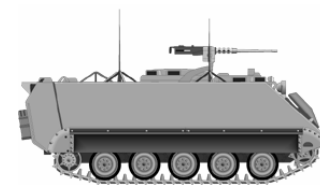

NAPCO: A long term source for M113 spares & components

Engaged in the supply of M113 spares and kits for the past 35 years, NAPCO has the manufacturing capability and tooling for most of the spares and major components for the M113A1, M113A2 and M113A3 versions as well as the unique components for all M113 variants. Special kits of all types are also available and can supply these parts at competitive prices and on relatively short lead times

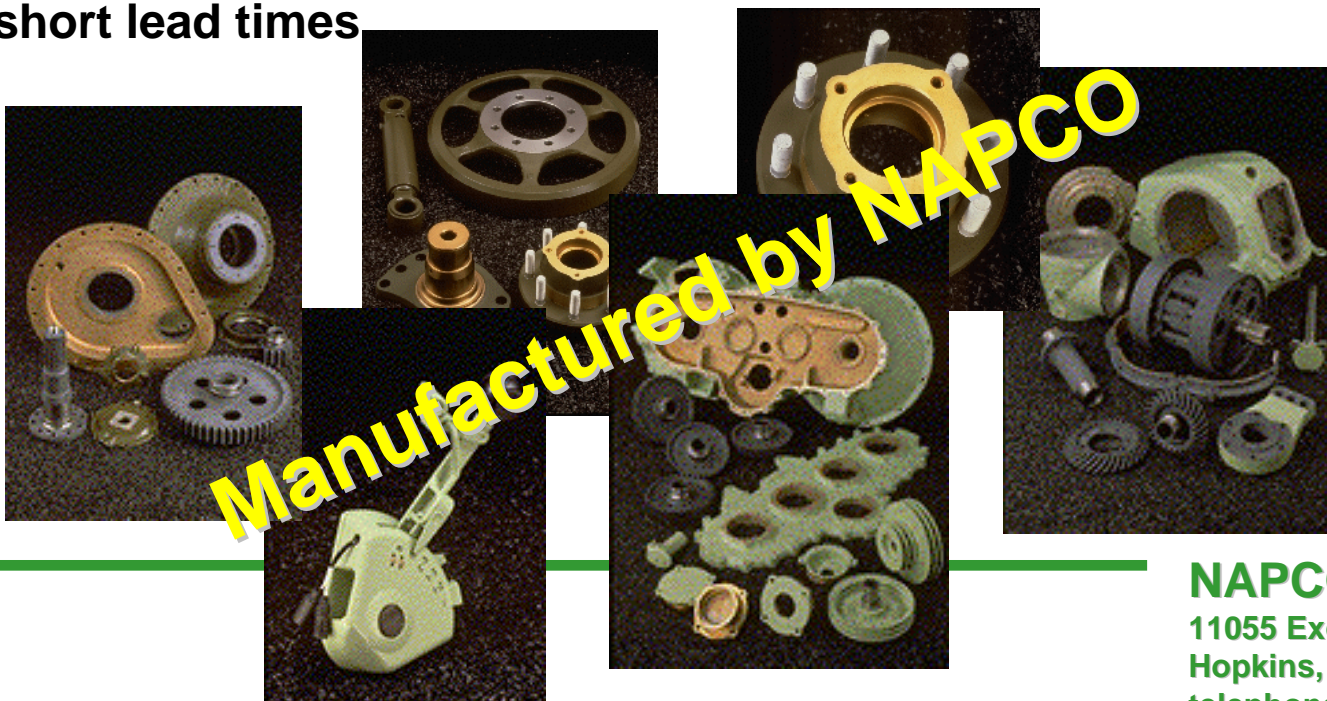

NAPCO International LLC

11055 Excelsior Blvd.

Hopkins, MN 55343 USA

telephone: (952) 931-2400

facsimile: (952) 931-2402

e-mail: napco@napcointl.com

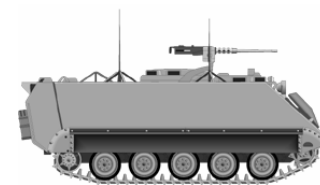

NAPCO: A Military Original Equipment Manufacturer (OEM)

In 1972, NAPCO was appointed a military OEM by Detroit Diesel Corporation. This status allows NAPCO to buy directly from Detroit Diesel & Allison to best supply our repower and dieselization customers.



The collaborative effort of the two companies, each with its own proven expertise, has resulted in a product of outstanding technical and commercial merit.

www.napcointl.com

NAPCO International LLC

11055 Excelsior Blvd.
Hopkins, MN 55343 USA
telephone: (952) 931-2400
facsimile: (952) 931-2402
e-mail: napco@napcointl.com

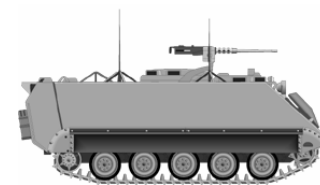

M113 Components & Conversion Kits Expertise

U.S. Government Contracts: Over the last 35 years NAPCO has won major contracts with the U.S. Department of Defense for the supply of major assemblies and kits of the M113, M113A1, M113A2 and M113A3. Assemblies included transfer gear cases, dieselization kits, final drives, instrument panels, steering differentials, fan drive assemblies and pumps.

Original Equipment Manufacturers (O.E.M.) Contracts: NAPCO manufactures M113A2 and M113A3 components and kits for major OEMs. Most conversion kits are being used in current U.S. Government upgrade programs.

International Contracts: NAPCO has also won major contracts for the supply of M113A1 and M113A2 conversion kits to Armed Forces around the World.

www.napcointl.com

NAPCO International LLC

11055 Excelsior Blvd.

Hopkins, MN 55343 USA

telephone: (952) 931-2400

facsimile: (952) 931-2402

e-mail: napco@napcointl.com

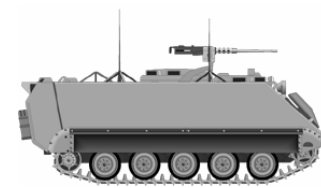

M113 Conversion Kits

1. M113A1 Conversion Kits

- Dieselization Kit
- Modernization Kit

2. M113A2 Conversion Kits

- Improved Suspension System (ISS) Kit
- Improved Cooling System (ICS) Kit
- Dual Air Personnel Heater Kit

3. M113A3 Conversion Kits

- Propulsion System Modernization Kit
- Spall Suppression Liners Kit
- External Fuel Tank Kit
- Add-on Armor (Optional)



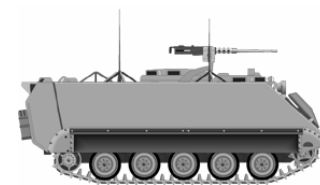

M113A1 Conversion Kits

Major benefits of the M113A1 conversion package include the increased crew safety that results from replacing gasoline with diesel fuel as well as a higher top speed and range increase of approximately 160 kilometers (100 miles) over the original M113.

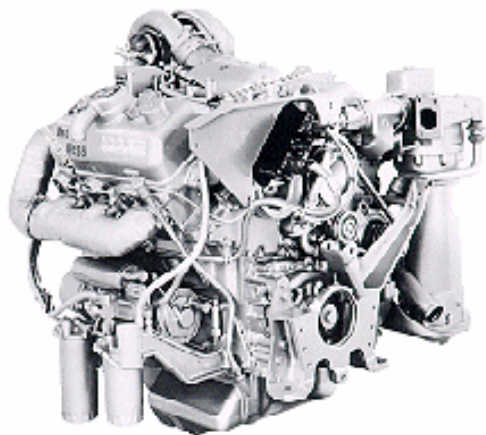

The Dieselization Kit replaces the 209 Hp Chrysler Model 75M gasoline engine of the original M113 with the highly reliable Detroit Diesel 6V53 engine rated at 212 Hp.

The package also replaces the transmission, transfer gear case, radiator and alternator with properly sized units.

www.napcointl.com

NAPCO International LLC

11055 Excelsior Blvd.

Hopkins, MN 55343 USA

telephone: (952) 931-2400

facsimile: (952) 931-2402

e-mail: napco@napcointl.com

NAPCO

M113 CAPABILITIES

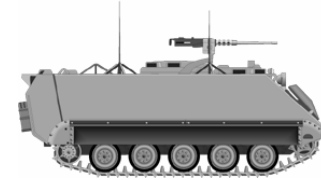

[The Modernization Kit](#) the technical data package developed for the conversion of the original M113 includes many modifications designed to improve the performance, maintainability, safety and reliability of the M113-A1. These improvements are not related to the dieselization but can easily be installed during the dieselization and rebuild of the vehicle.

M113A1 Conversion Kits

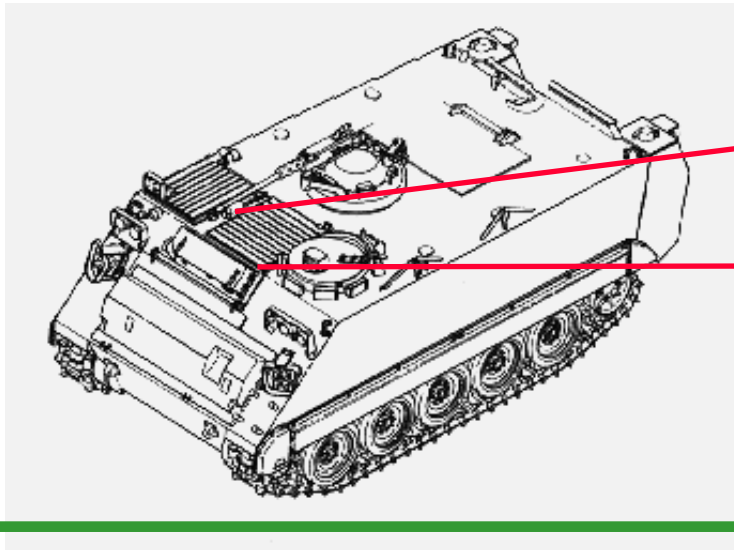

Modernization Kit

Dieselization Kit

www.napcointl.com

NAPCO International LLC

11055 Excelsior Blvd.
Hopkins, MN 55343 USA
telephone: (952) 931-2400
facsimile: (952) 931-2402
e-mail: napco@napcointl.com

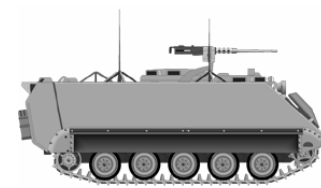

M113A2 Conversion Kits

Major benefits of the M113A2 conversion package include improvements in the areas of cooling, suspension, and personnel heating systems. The changes provide better cross-country mobility, increased cooling efficiency, and longer engine life.

1. the **Improved Suspension System Kit** consists of:

- adding shock absorbers on each side of the road wheel stations
- installing new high strength torsion bars
- improving and relocating the rear idler assembly

2. the **Improved Cooling System Kit** consists of:

- upgrading and relocating cooling fan and radiator
- increasing the radiator's capacity and fan speed
- adding a surge tank for more positive deaeration of the coolant

www.napcointl.com

NAPCO International LLC

11055 Excelsior Blvd.

Hopkins, MN 55343 USA

telephone: (952) 931-2400

facsimile: (952) 931-2402

e-mail: napco@napcointl.com

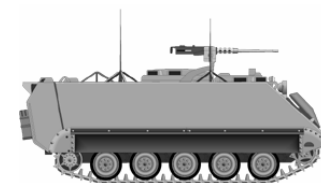

M113A2 Conversion Kits

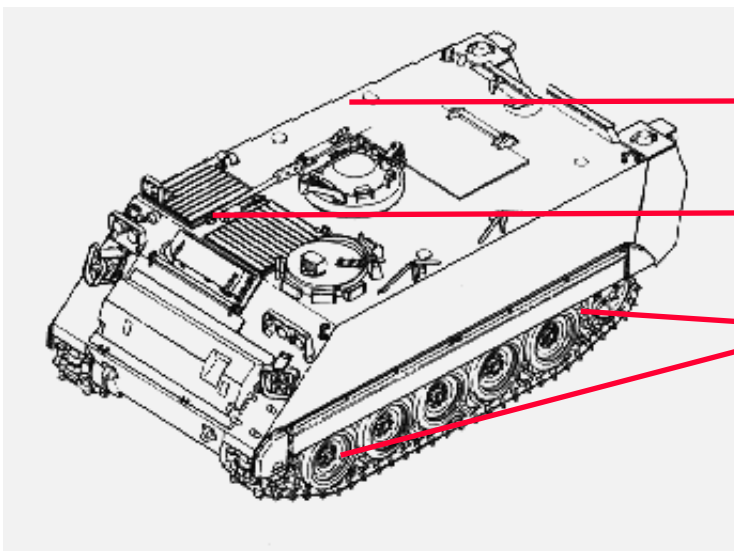

Dual Heater Personnel Kit

ICS Kit

ISS Kit

www.napcointl.com

NAPCO International LLC

11055 Excelsior Blvd.

Hopkins, MN 55343 USA

telephone: (952) 931-2400

facsimile: (952) 931-2402

e-mail: napco@napcointl.com

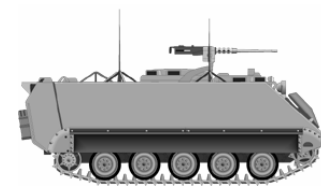

M113A3 Conversion Kits

The standard M113A3 package includes a turbocharged engine and upgraded transmission system, greatly improved driver controls, external fuel tanks, 200AMP alternator and 4 batteries. Additional A3 improvements include incorporation of spall liners and provisions for mounting external armor.

1. Propulsion System Modernization Kit:

- the Propulsion System Modernization Kit contains all the components necessary to install the OEM or US Government supplied 6V53T turbocharged engine and X200-4 transmission.

2. Spall Suppression Liners Kit

- the Spall Suppression Liners limit troop injuries from the effect of overmatching weapons by restricting the spread of spall if a round penetrates the hull.

www.napcointl.com

NAPCO International LLC

11055 Excelsior Blvd.

Hopkins, MN 55343 USA

telephone: (952) 931-2400

facsimile: (952) 931-2402

e-mail: napco@napcointl.com

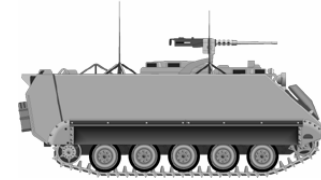

3. Add-On Armor Kit

- a variety of add-on armor kits are available from NAPCO International Inc.

4. External Fuel Tank Kit

- both internal fuel tanks are moved outside the crew compartment.

M113A3 Conversion Kits

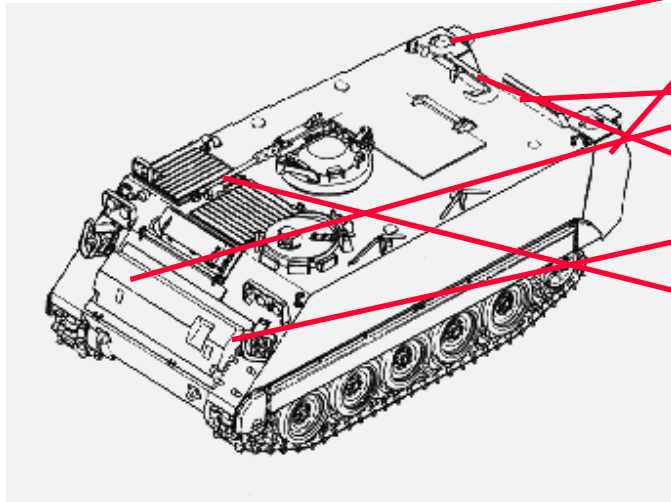

External Fuel Tank

Add-On Armor Kit

Spall Suppression Liner Kit

Propulsion System

NAPCO International LLC

11055 Excelsior Blvd.

Hopkins, MN 55343 USA

telephone: (952) 931-2400

facsimile: (952) 931-2402

e-mail: napco@napcointl.com

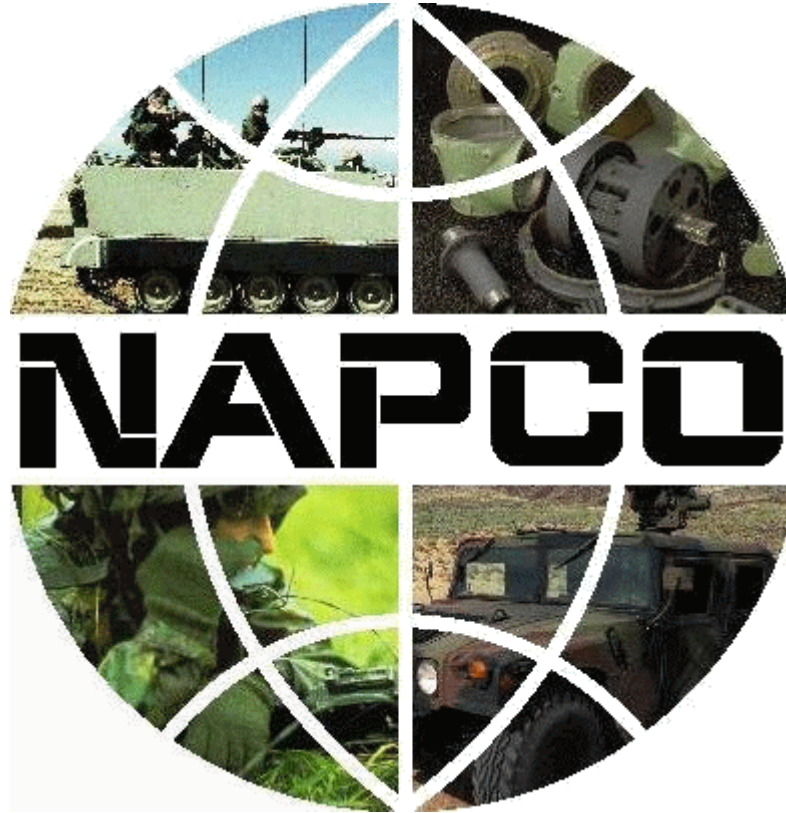

NAPCO

www.napcointl.com

NAPCO International LLC

**11055 Excelsior Boulevard, Hopkins, MN 55343 USA
Telephone: (952) 931-2400 - Facsimile: (952) 931-2402
E-mail: napco@napcointl.com**